

Blockhaus 28 (570x280)

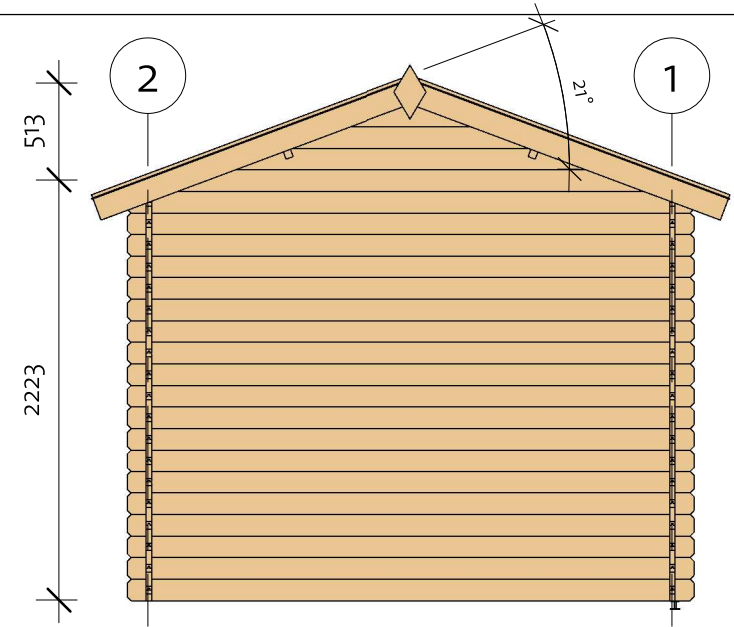

Blockhaus 28 (570x280)

Floor Plan

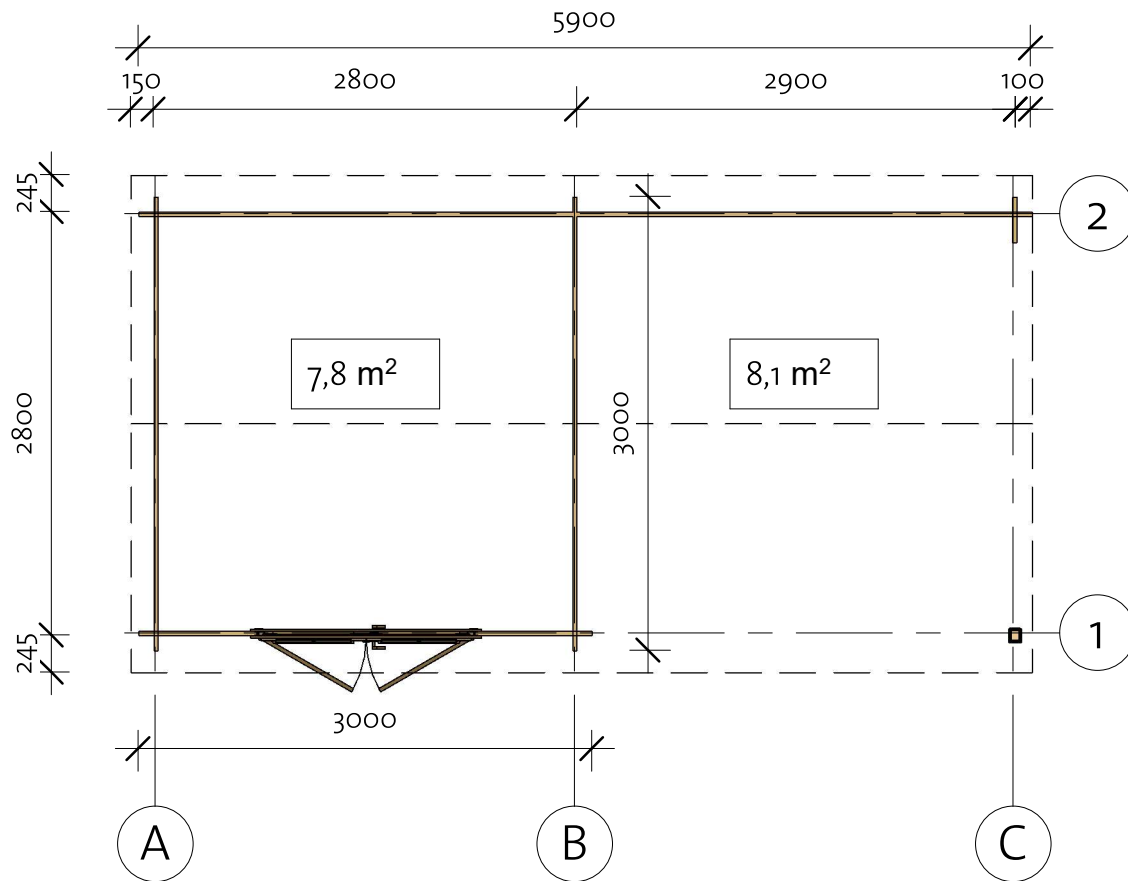
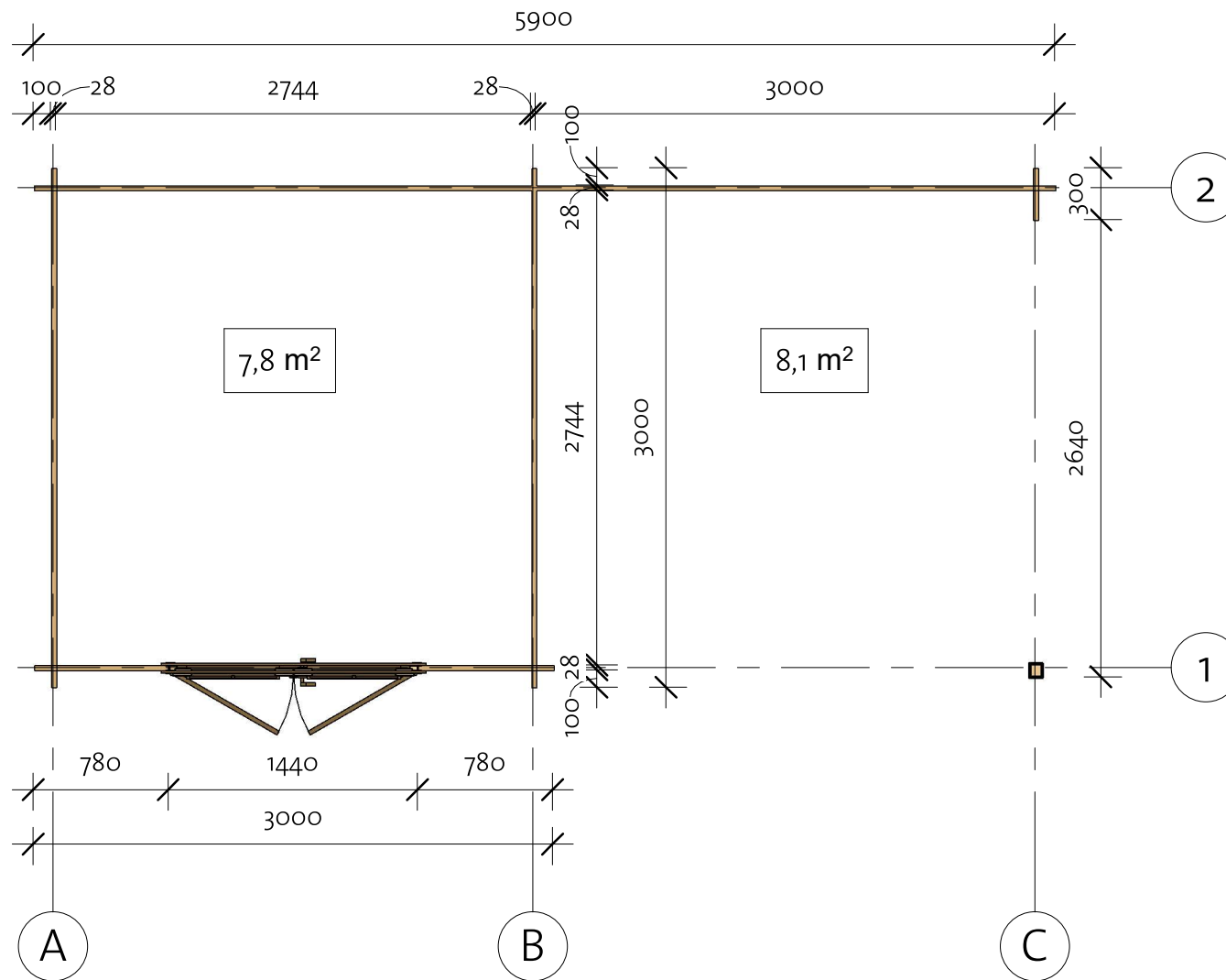

Blockhaus 28 (570x280)

Wall 1

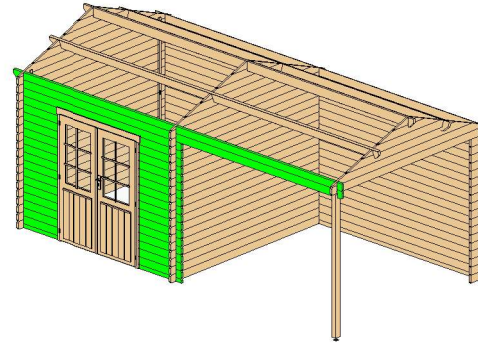

Wall 1			
Mark	Profile	Count	Cut Length

1BL-1	28x57	2	780
1LG-1	28x114	32	780
1LG-2	28x114	1	5900
1LG-3	28x114	1	3000
1TL-1	28x114	1	5950

Log Profile Wall 1	
Profile	Profile

28x57	
28x114	
28x114	

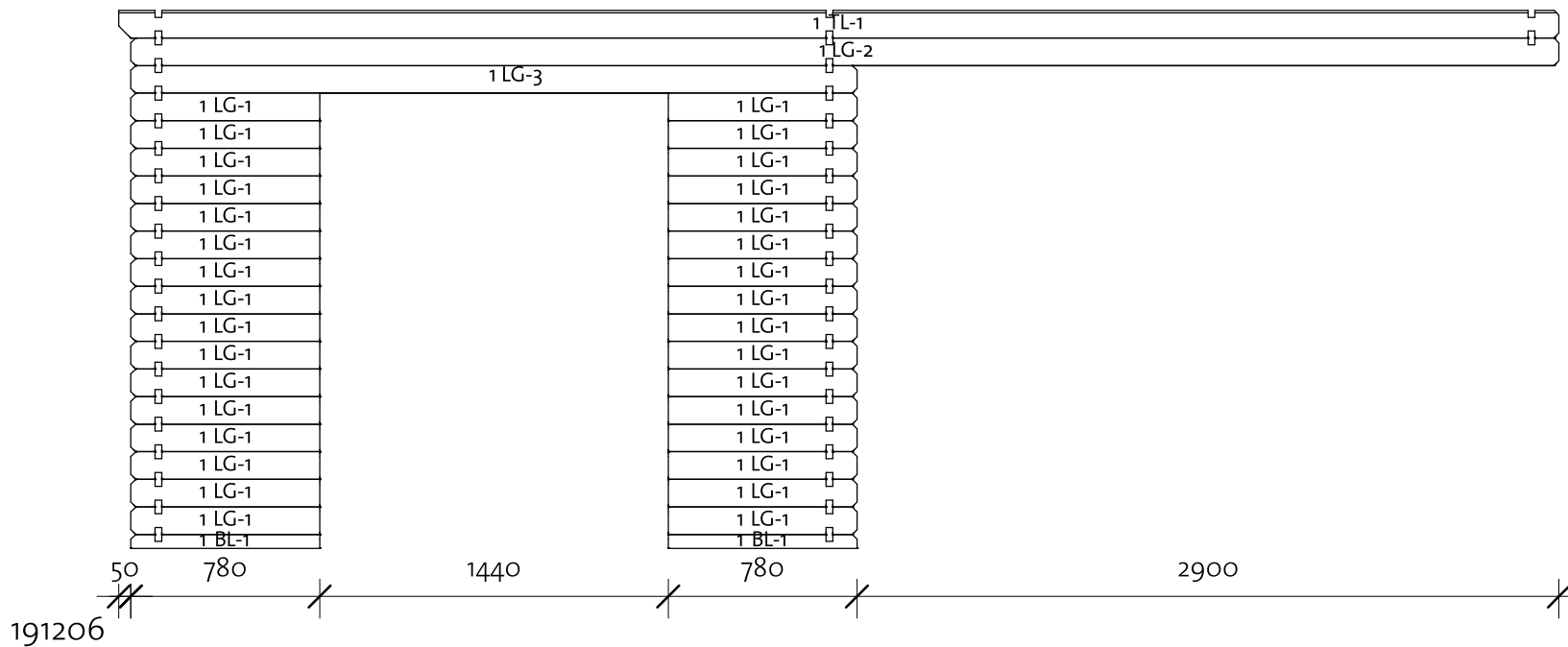

Blockhaus 28 (570x280)

Wall B

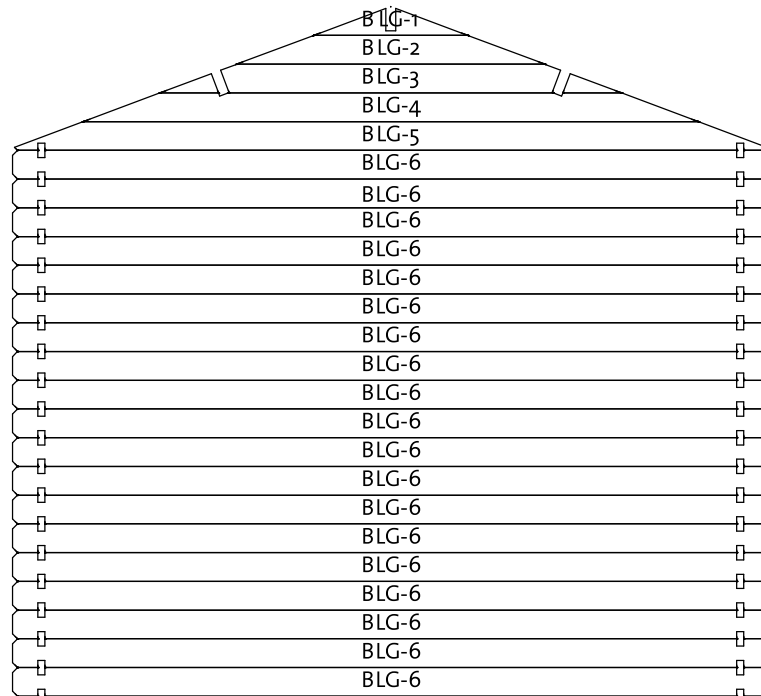
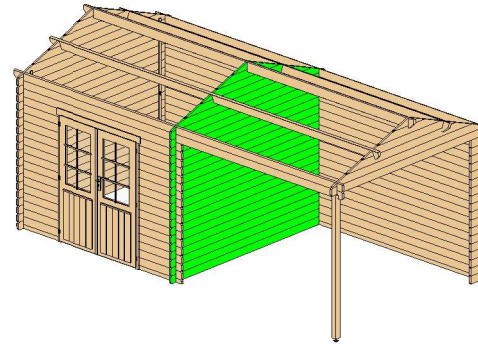

Wall B			
Mark	Profile	Count	Cut Length

BLG-1 *	28x114	1	611
BLG-2 *	28x114	1	1221
BLG-3 *	28x114	1	1830
BLG-4 *	28x114	1	2439
BLG-5 *	28x114	1	2984
BLG-6	28x114	19	3000

* Gable - delivered premounted

Log Profile Wall B	
Profile	Profile

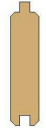
28x114	
--------	---

Blockhaus 28 (570x280)

Wall C

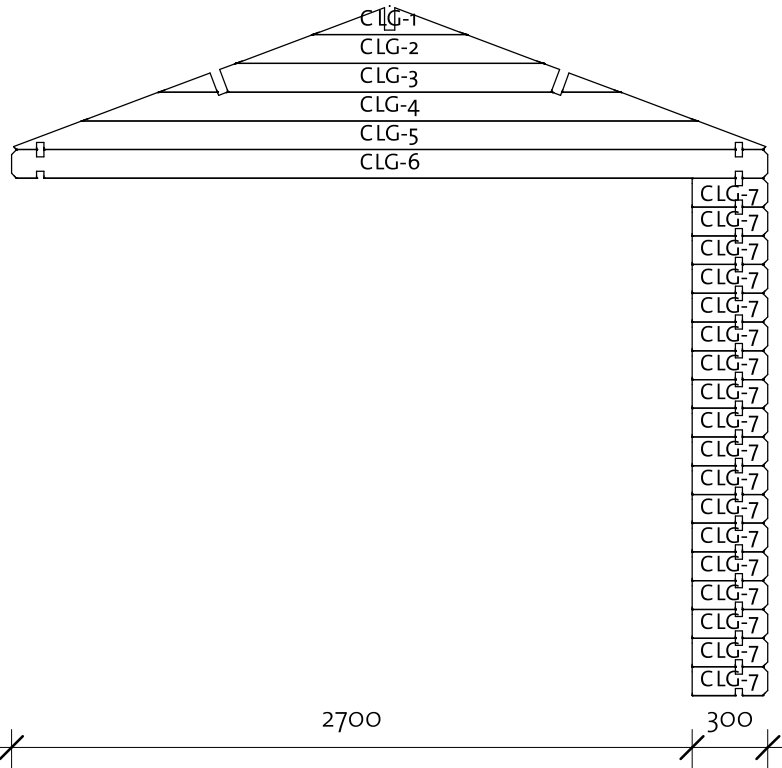
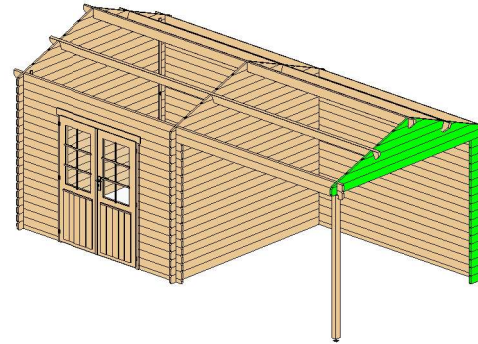

Wall C			
Mark	Profile	Count	Cut Length

CLG-1*	28x114	1	611
CLG-2*	28x114	1	1221
CLG-3*	28x114	1	1830
CLG-4*	28x114	1	2439
CLG-5*	28x114	1	2984
CLG-6	28x114	1	3000
CLG-7	28x114	18	300

* Gable - delivered premounted

Log Profile Wall C

Profile

Profile

28x114

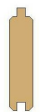

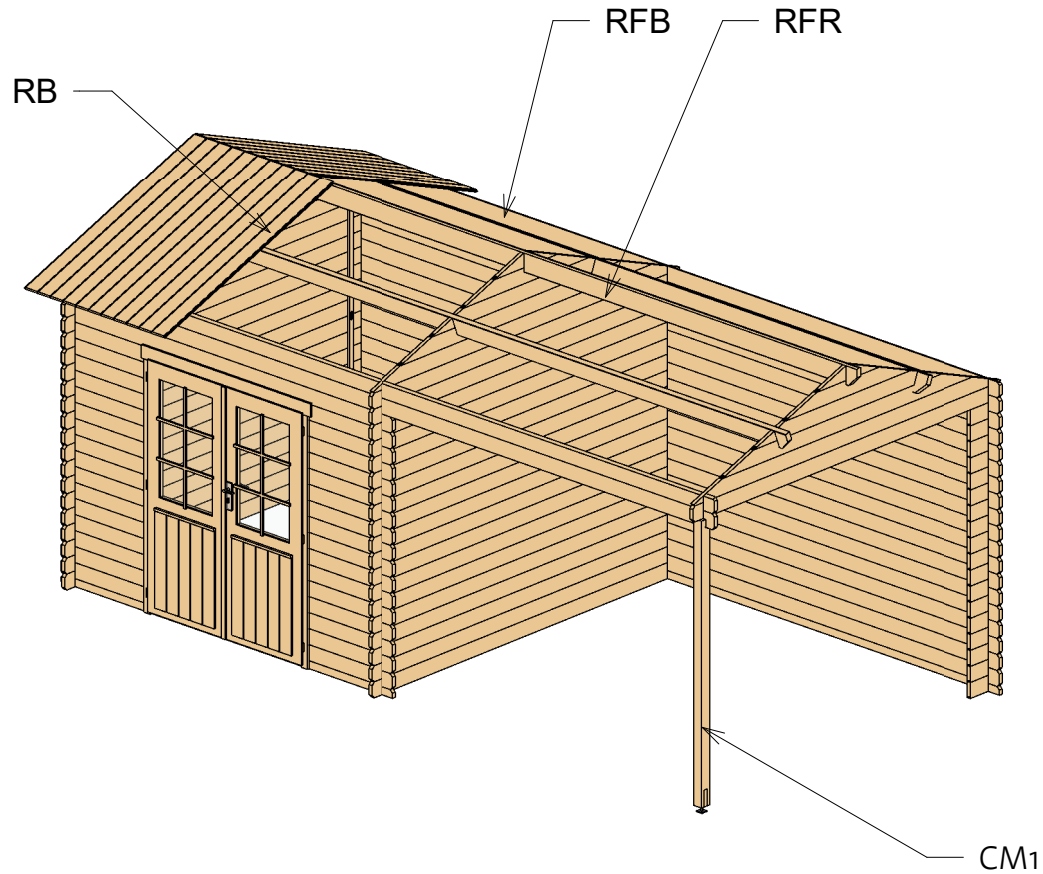

Blockhaus 28 (570x280)

Roof 1



Roof				
Mark	Type	Profile	Count	Length

RFR	Ridge 40x143		1	5950
RFB	Beam 40x143		2	5950
RB	17x114		108	1750

Column schedule			
Mark	Type	Length	Count

CM1	Post 80x70	2052	1
-----	------------	------	---

Blockhaus 28 (570x280)

Roof 2

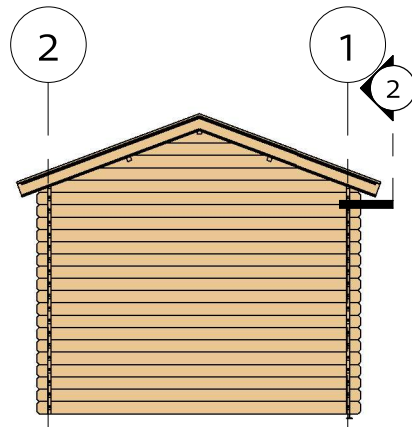

② Roof Reinforcement

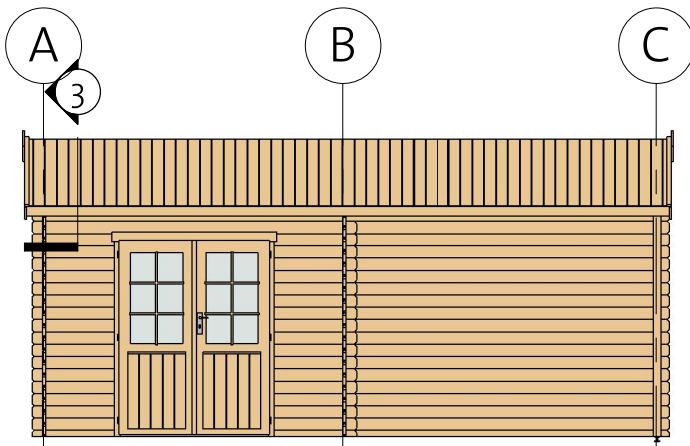
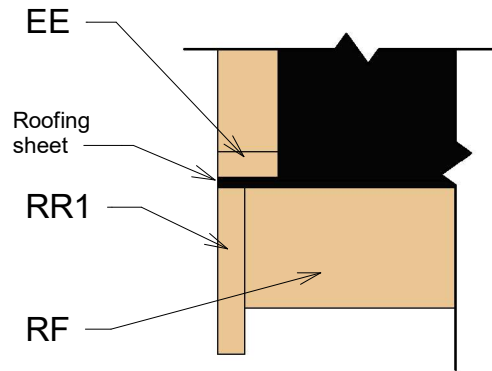



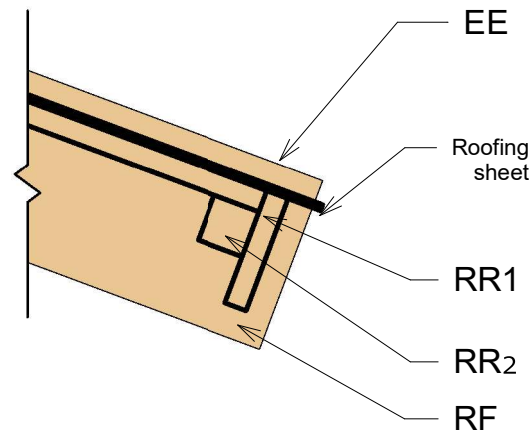







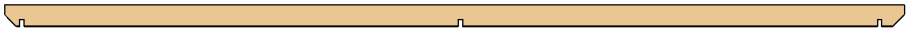



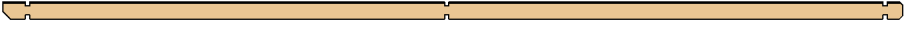

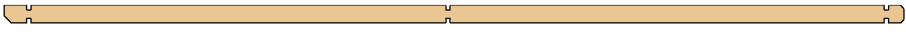

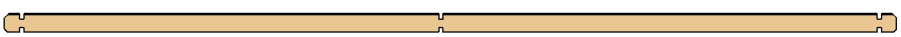
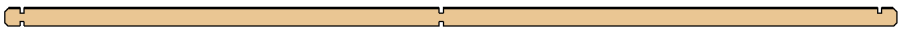
③ Facia







Fascia Schedule				
Mark	Type	Profile	Count	Length
EE	Eave Edging 18x40		4	1795
RF	Roof Fascia 18x120		4	1795
RR1	Roof reinforce ment 18x95		2	5950
RR2	Roof reinforce ment 38x38		2	5950

Blockhaus 28 (570x280)

List of all items 1

	RFB	Beam 40x143			2	5950
	RFR	Ridge 40x143			1	5950
1	TL-1	Log 28x114			1	5950
2	TL-1	Log 28x114			1	5950
2	BL-1	Log 28x57			1	5900
2	LG-1	Log 28x114			18	5900
1	LG-2	Log 28x114			1	5900
1	LG-3	Log 28x114			1	3000
A	LG-6				19	3000
B	LG-6	Log 28x114			19	3000
C	LG-6	Log 28x114			1	3000
	RB	17x114			108	1750
1	BL-1	Log 28x57			2	780
1	LG-1	Log 28x114			32	780
C	LG-7	Log 28x114			18	300

RR1	Roof reinforce ment 18x95			2	5950
RR2	Roof reinforce ment 38x38			2	5950
EE	Eave Edging 18x40			4	1795
RF	Roof Fascia 18x120			4	1795

CM1	Post 80x70			1	2052
-----	------------	---	--	---	------

Windboard 18x40			5	2200
-----------------	---	--	---	------

Blockhaus 28 (570x280)

List of all items 2

1 Gable A



3 Gable C

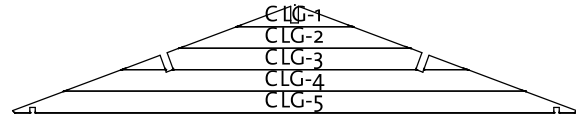

2 Gable B

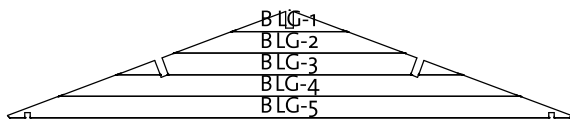

Romb	2
------	---







Adjustable post foot	1	45
----------------------	---	----

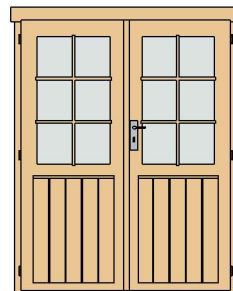

Door Schedule				
Model	Type	Width	Height	Count
BDD5R	Basic double door 5 right	1425	1835	1
DCB6	Door Crossbar 6	--	--	2

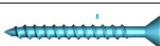

Hitblock	300-400 mm		
Bolts	M8x60		15
Screws	5,0 x 70		20
Screws	6,0 x 140		25
Screws	4,0 x 40		90
Screws	4,0 x 50		365